

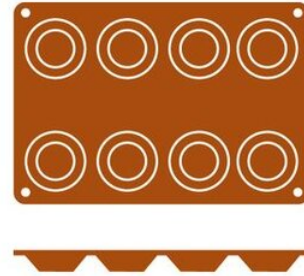

Frenti

Manufactured in 100% silicon. The moulds are suitable for food contact as per H.A.C.C.P. laws. The surface is non-stick so it is not necessary to grease it before use. The flexibility of the moulds guarantees a quick and easy removal. The moulds are easy to clean with hot water and a soft sponge. dishwasher safe, minimum maintenance, long durability and maximum resistance to torsion. The resistance of the moulds to extreme temperatures from -60°C to +280°C makes them ideal for freezing or for baking. It can also be used for all preparations of cakes, chocolates, petit-fours and catering preparations.



PRODUCT ITEMS

Item Img	Item Number	Details	Height	Diameter	Size overall	Capacity	Brand	Material	Features	Number of moulds
	54615	8 Cup	17mm	60mm	300 x 175mm	40ml	Frenti	Silicon	Microwave Safe, Oven Safe, Dishwasher Safe, Freezer Safe	8